

LEAK SENSORS

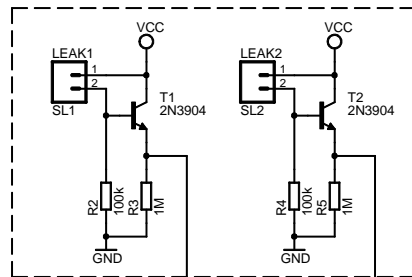

CURRENT SENSOR OR ADC INPUT

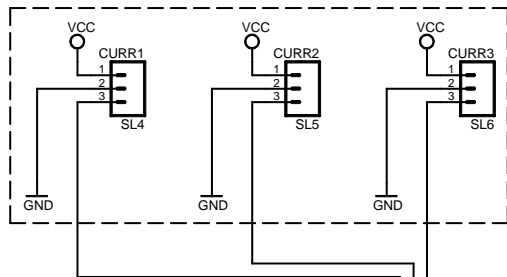

PRESSURE SENSOR

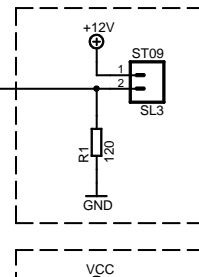

RS485

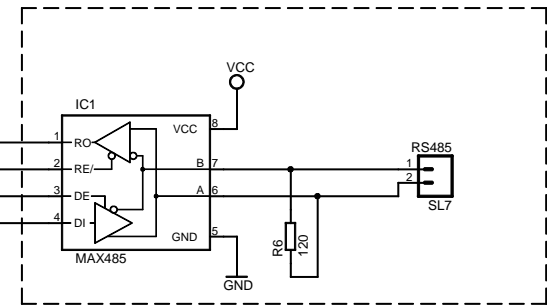

BOB3 VIDEO OVERLAY

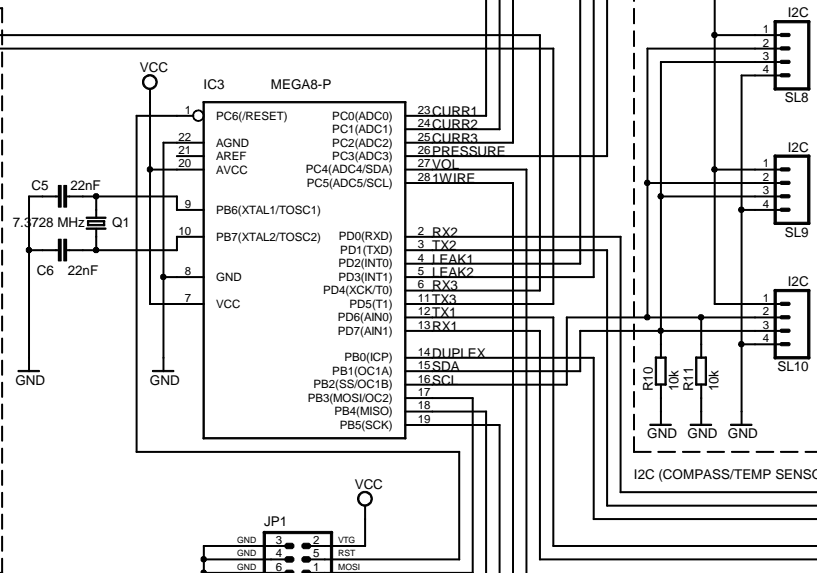
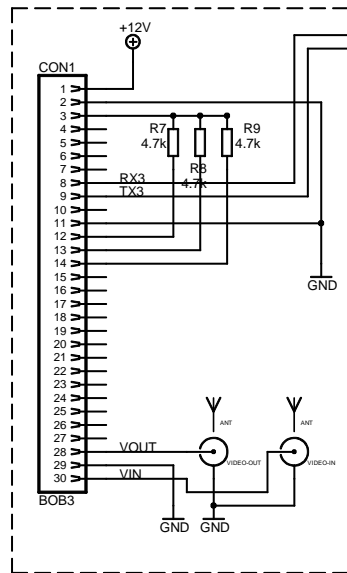

RS232

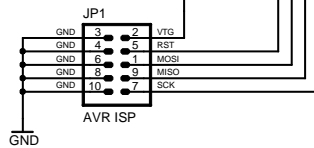
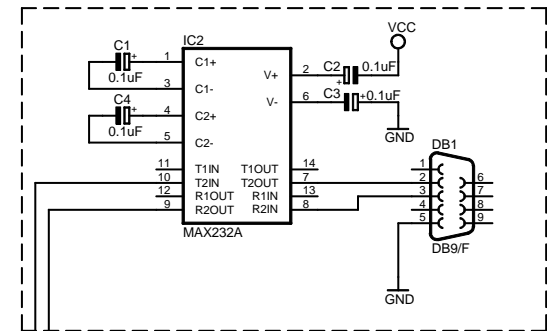

VOLTAGE

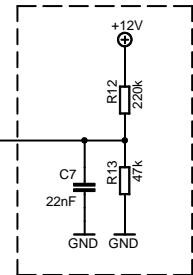

POWER

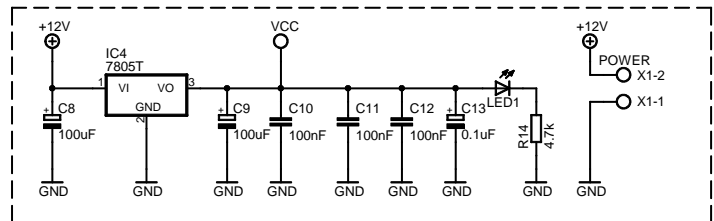

1-WIRE BUS

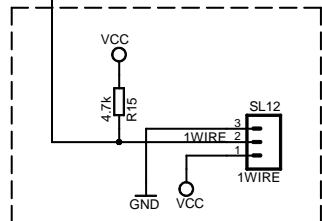

<h1>AQUATICUS ROV</h1>	
TITLE: ROV Sensor Board	
Document Number: http://aquaticus.info/rov_sensor_board	REV: E
Date: 2006-11-15 20:23:14	Sheet: 1/1